

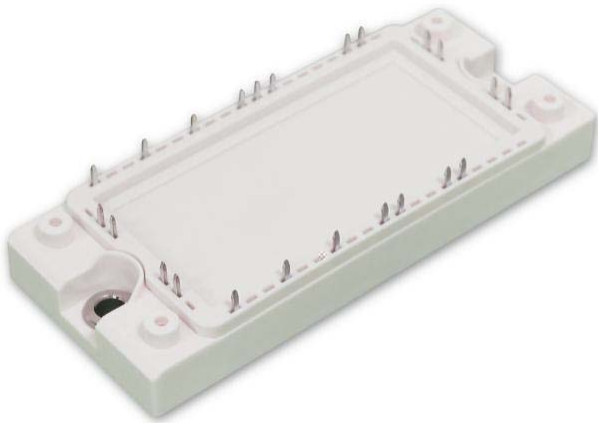

## IGBT Modules



$V_{CES}$             1200V  
 $I_C$                  50A

## Applications

- Motor Drivers
- AC and DC servo drive amplifier
- UPS (Uninterruptible Power Supplies)

## Features

- Low switching losses
- Low  $V_{ce(sat)}$  with positive temperature coefficient
- Including fast & soft recovery anti-parallel FWD
- Low inductance case
- High short circuit capability(10us)
- Maximum junction temperature 175°C

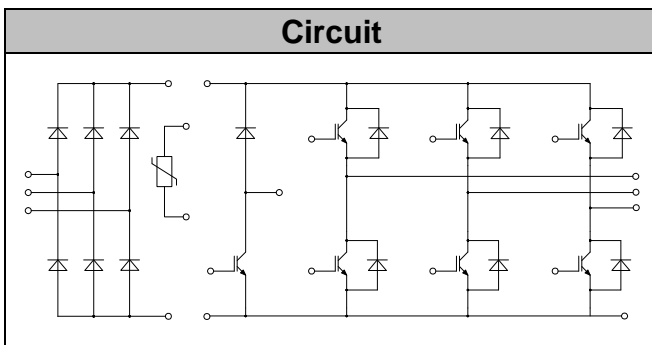

## ● IGBT- inverter

### Absolute Maximum Ratings

Parameter	Symbol	Conditions	Value	Unit
Collector-Emitter Voltage	$V_{CES}$	$V_{GE}=0V, I_C=1mA, T_{vj}=25$	1200	V
Continuous Collector Current	$I_C$	$T_c=100, T_{vjmax}=175$	50	A
Repetitive Peak Collector Current	$I_{CRM}$	$tp=1ms$	100	A
Gate-Emitter Voltage	$V_{GES}$	$T_{vj}=25$	$\pm 20$	V
Total Power Dissipation	$P_{tot}$	$T_c=25$ $T_{vjmax}=175$	288	W



## ● IGBT- inverter

### Characteristic values

Parameter	Symbol	Conditions	Value			Unit	
			Min.	Typ.	Max.		
Gate-emitter Threshold Voltage	$V_{GE(th)}$	$V_{GE}=V_{CE}, I_C=2.0mA, T_{vj}=25$	5.2	5.8	6.4	V	
Collector-Emitter Cut-off Current	$I_{CES}$	$V_{CE}=1200V, V_{GE}=0V, T_{vj}=25^{\circ}C$			1.0	mA	
Collector-Emitter Saturation Voltage	$V_{CE(sat)}$	$I_C=50A, V_{GE}=15V, T_{vj}=25$		1.90	2.30	V	
		$I_C=50A, V_{GE}=15V, T_{vj}=125$		2.30			
		$I_C=50A, V_{GE}=15V, T_{vj}=150$		2.40			
Gate Charge	$Q_G$			0.35		uC	
Input Capacitance	$C_{ies}$	$V_{CE}=25V, V_{GE}=0V, f=1MHz, T_{vj}=25^{\circ}C$		2.60		nF	
Reverse Transfer Capacitance	$C_{res}$			0.10		nF	
Gate-Emitter leakage current	$I_{GES}$	$V_{CE}=0V, V_{GE}=20V, T_{vj}=25$			400	nA	
Turn-on Delay Time	$t_{d(on)}$	$I_C=50A, V_{CE}=600V, V_{GE}=\pm 15V, R_G=15\Omega, T_{vj}=25$		168		ns	
Rise Time	$t_r$			34		ns	
Turn-off Delay Time	$t_{d(off)}$			320		ns	
Fall Time	$t_f$			78		ns	
Energy Dissipation During Turn-on Time	$E_{on}$			5.42		mJ	
Energy Dissipation During Turn-off Time	$E_{off}$			4.15		mJ	
Turn-on Delay Time	$t_{d(on)}$		$I_C=50A, V_{CE}=600V, V_{GE}=\pm 15V, R_G=15\Omega, T_{vj}=125$		175		ns
Rise Time	$t_r$				42		ns
Turn-off Delay Time	$t_{d(off)}$				426		ns
Fall Time	$t_f$				148		ns
Energy Dissipation During Turn-on Time	$E_{on}$			7.26		mJ	
Energy Dissipation During Turn-off Time	$E_{off}$			5.80		mJ	
SC Data	$I_{sc}$	$T_p \leq 10\mu s, V_{GE}=15V, T_{vj}=150, V_{cc}=900V, V_{CEM} \leq 1200V$			260		A



# MG50P12E1A

---



## ● IGBT-brake-chopper

### Absolute Maximum Ratings

Parameter	Symbol	Conditions	Value	Unit
Collector-Emitter Voltage	$V_{CES}$	$V_{GE}=0V, I_C=1mA, T_{vj}=25$	1200	V
Continuous Collector Current	$I_C$	$T_c=100, T_{vjmax}=175$	35	A
Repetitive Peak Collector Current	$I_{CRM}$	$t_p=1ms$	70	A
Gate-Emitter Voltage	$V_{GES}$	$T_{vj}=25$	$\pm 20$	V
Total Power Dissipation	$P_{tot}$	$T_c=25$ $T_{vjmax}=175$	227	W

### Characteristic values

Parameter	Symbol	Conditions	Value			Unit
			Min.	Typ.	Max.	
Gate-emitter Threshold Voltage	$V_{GE(th)}$	$V_{GE}=V_{CE}, I_C=1.4mA, T_{vj}=25$	5.2	6.0	6.8	V

Cos0.750 .113054c 0 SCN[(=25)] TJETQBT/TT11 1.00 Tf0.001 Tc0.012 Tw/GS1 gs0.750 w1 j10.500000 -0 362.580139 455.000305 Tm



Turn-on Delay Time	$t_{d(on)}$	$I_C = 35\text{ A}$ $V_{CE} = 600\text{ V}$ $V_{GE} = \pm 15\text{ V}$ $R_G = 12\Omega$ $T_{vj} = 125$	38	ns
Rise Time	$t_r$		21	ns
Turn-off Delay Time	$t_{d(off)}$		178	ns
Fall Time	$t_f$		170	ns
Energy Dissipation During Turn-on Time	$E_{on}$		2.90	mJ
Energy Dissipation During Turn-off Time	$E_{off}$		2.90	mJ
SC Data	$I_{sc}$		$T_p \leq 10\mu s, V_{GE} = 15\text{ V}, T_{vj} = 150$ , $V_{cc} = 900\text{ V}, V_{CEM} \leq 1200\text{ V}$	150

## ● Diode-Brake-Chopper

### Absolute Maximum Ratings

Parameter	Symbol	Conditions	Value	Unit
Repetitive Peak Reverse Voltage	$V_{RRM}$	$T_j = 25$	1200	V
Continuous DC Forward Current	$I_F$		15	A
Repetitive Peak Forward Current	$I_{FRM}$	$t_p = 1\text{ ms}$	30	A
$I^2t$ -value	$I^2t$	$V_R = 0, t_p = 10\text{ ms}, T_j = 125$	48.0	A <sup>2</sup> s
		$V_R = 0, t_p = 10\text{ ms}, T_j = 150$	42.0	

### Characteristic values

Parameter	Symbol	Conditions	Value			Unit
			Min.	Typ.	Max.	
Forward Voltage	$V_F$	$I_F = 15\text{ A}, T_{vj} = 25$		1.95		V
		$I_F = 15\text{ A}, T_{vj} = 125$		1.80		
		$I_F = 15\text{ A}, T_{vj} = 150$		1.70		
Recovered Charge	$Q_{rr}$	$I_F = 15\text{ A}$		1.10		$\mu\text{C}$
Peak Reverse Recovery Current	$I_{rr}$	$V_R = 600\text{ V}$ $-di_F/dt = 550\text{ A}/\mu\text{s}$		12.0		A
Reverse Recovery Energy	$E_{rec}$	$T_{vj} = 25$		0.30		mJ
Recovered Charge	$Q_{rr}$	$I_F = 15\text{ A}$		1.90		$\mu\text{C}$
Peak Reverse Recovery Current	$I_{rr}$	$V_R = 600\text{ V}$ $-di_F/dt = 550\text{ A}/\mu\text{s}$		14.0		A
Reverse Recovery Energy	$E_{rec}$	$T_{vj} = 125$		0.60		mJ



## ● Diode-Rectifier

### Absolute Maximum Ratings

Parameter	Symbol	Conditions	Value	Unit
Repetitive Peak Reverse Voltage	$V_{RRM}$	$T_j=25$	1600	V
Average output Current 50/60Hz, sine wave	$I_{F(AV)}$	$T_c=100$	50	A
Maximum RMS Current at Rectifier Output	$I_{RMSM}$	$T_c=100$	100	A
Surge Forward Current	$I_{FSM}$	$V_R=0, t_p=10ms, T_j=45$	525	A
$I^2t$ -value	$I^2t$	$V_R=0, t_p=10ms, T_j=45$	1378	A <sup>2</sup> s

### Characteristic values

Parameter	Symbol	Conditions	Value			Unit
			Min.	Typ.	Max.	
Diode Forward Voltage	$V_F$	$I_F=50A, T_j=125$		1.0		V
Reverse Current	$I_R$	$T_j=125, V_R=1600V$			1.5	mA

## ● NTC-Thermistor

### Characteristic values

Parameter	Symbol	Conditions	Value			Unit
			Min.	Typ.	Max.	
Rated Resistance	$R_{25}$			5.0		k
Deviation of R100	R/R	$T_c=100, R_{100}=493.3$	-5		5	%
Power Dissipation	$P_{25}$				20.0	mW
B-value	$B_{25/50}$	$R_2=R_{25}\exp[B_{25/50}(1/T_2-1/(298.15 K))]$		3375		K



## ● Module Characteristics

$T_C=25^\circ\text{C}$  unless otherwise specified

Parameter	Symbol	Conditions	Value			Unit
			Min.	Typ.	Max.	
Isolation voltage	$V_{\text{isol}}$	$t=1\text{min}, f=50\text{Hz}$	2500			V
Maximum Junction Temperature	$T_{\text{jmax}}$				175	
Operating Junction Temperature	$T_{\text{vj op}}$		-40		150	
Storage Temperature	$T_{\text{stg}}$		-40		125	
Stray-inductance-module	$L_{\text{SCE}}$			60		nH
Module lead resistance, terminals-chip	$R_{\text{cc'+EE'}}$	$T_C=25^\circ\text{C}$ , per switch		4.0		m
	$R_{\text{AA'+CC'}}$			3.0		

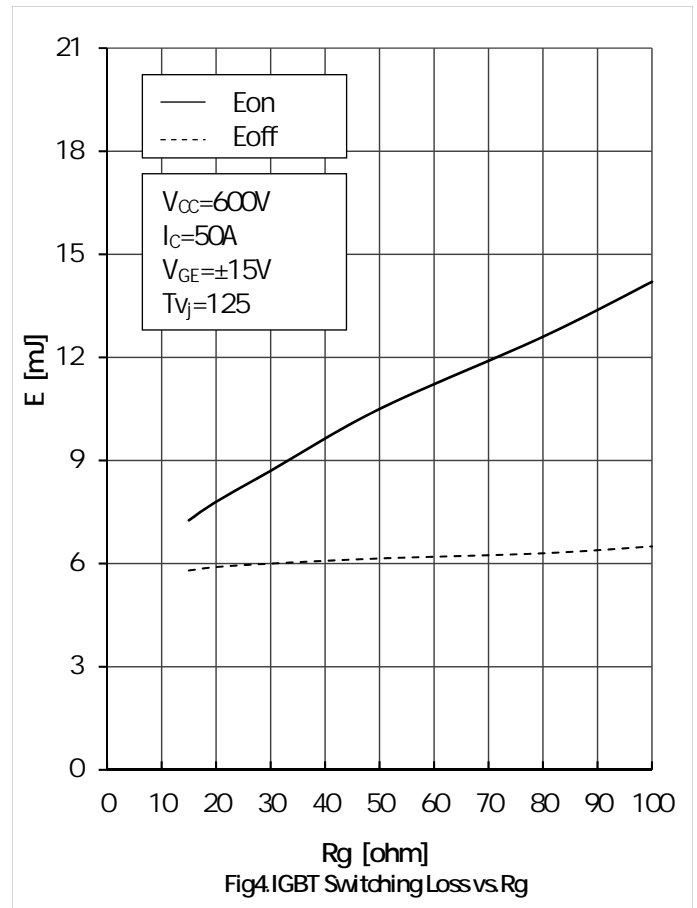
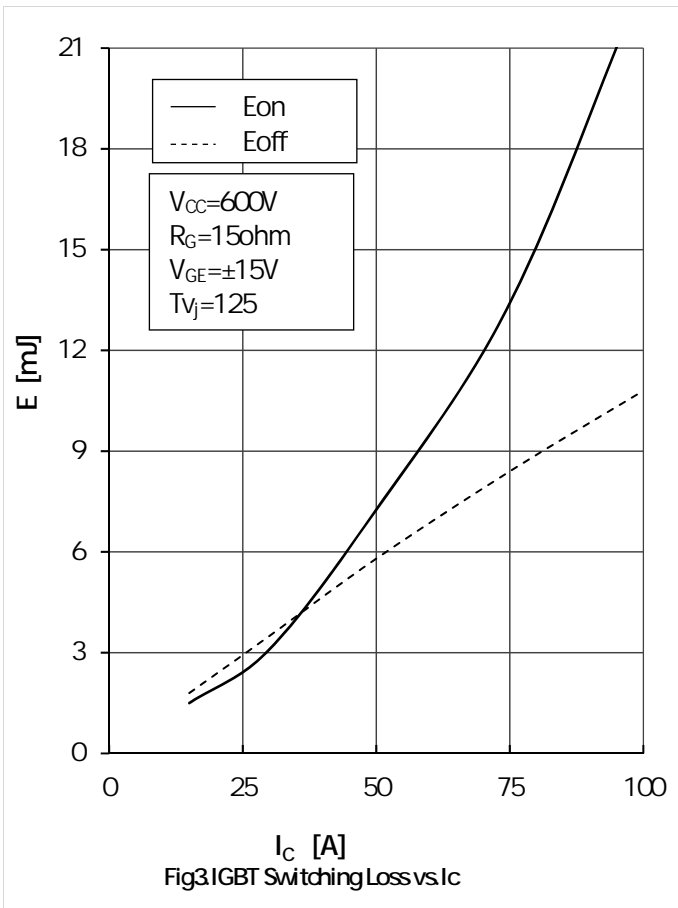
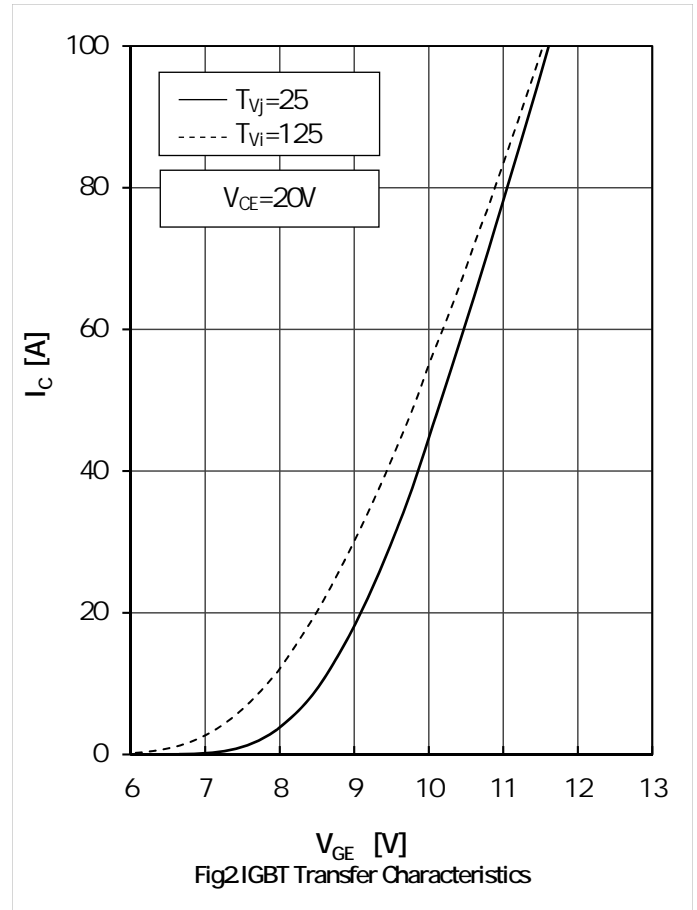
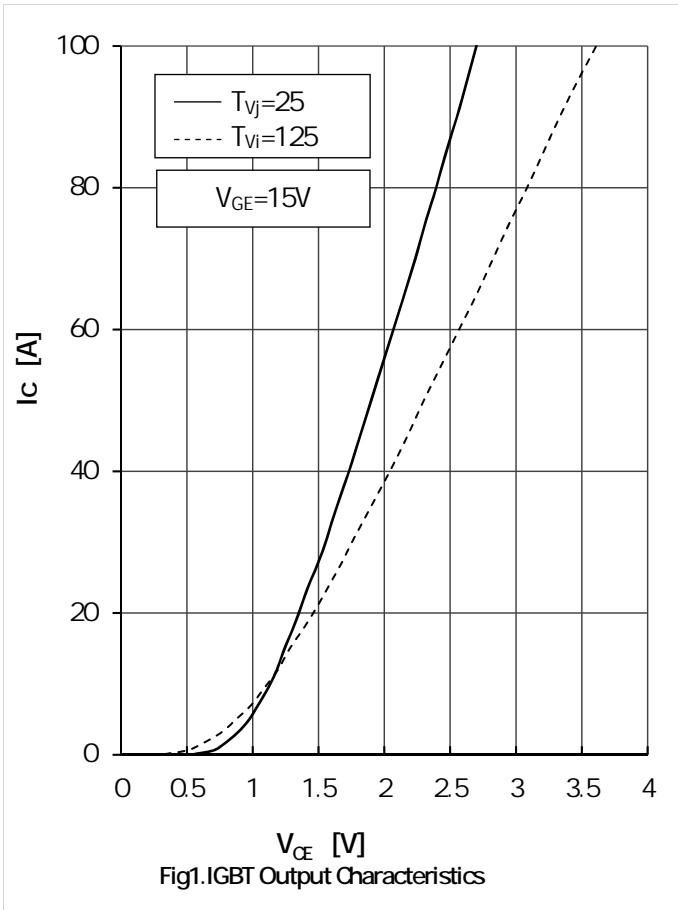



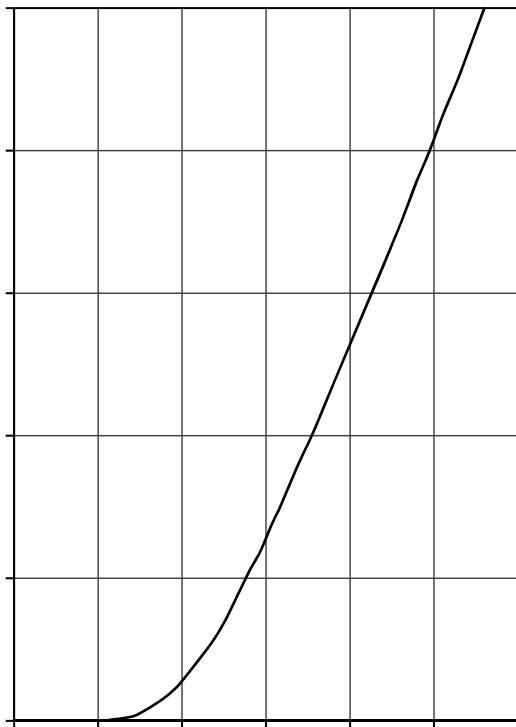
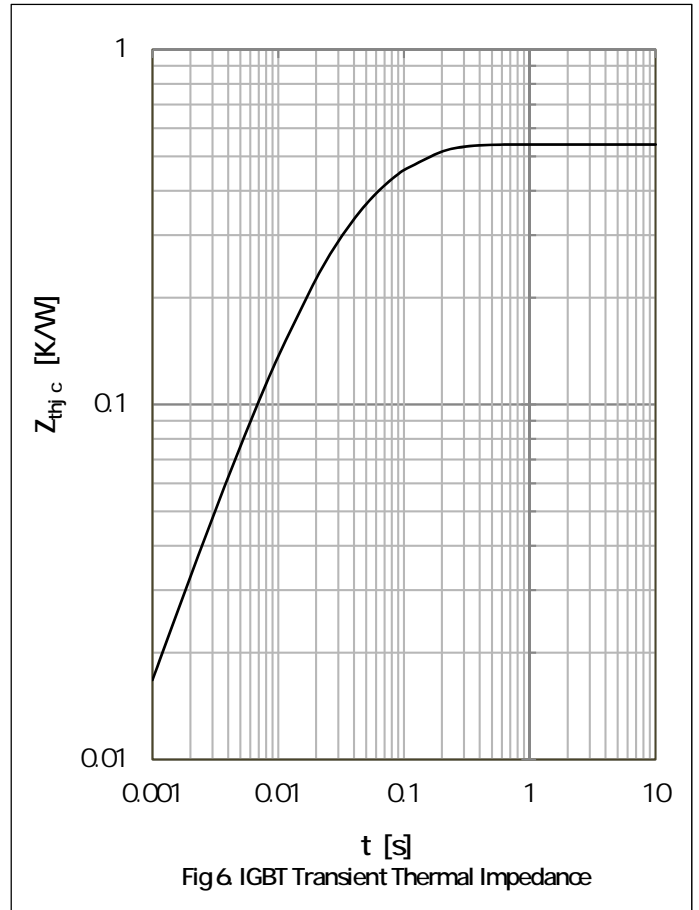
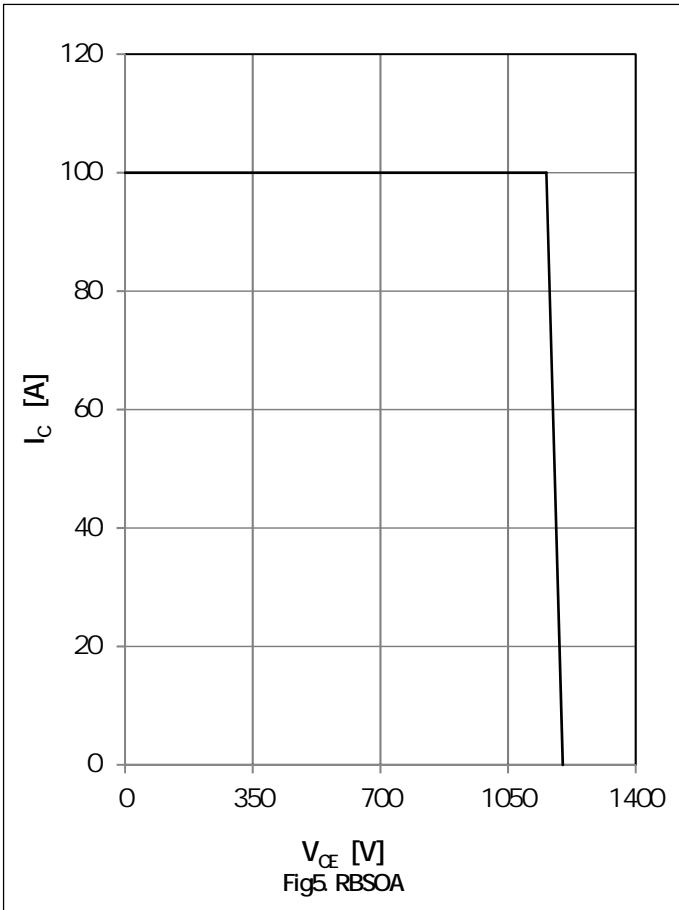

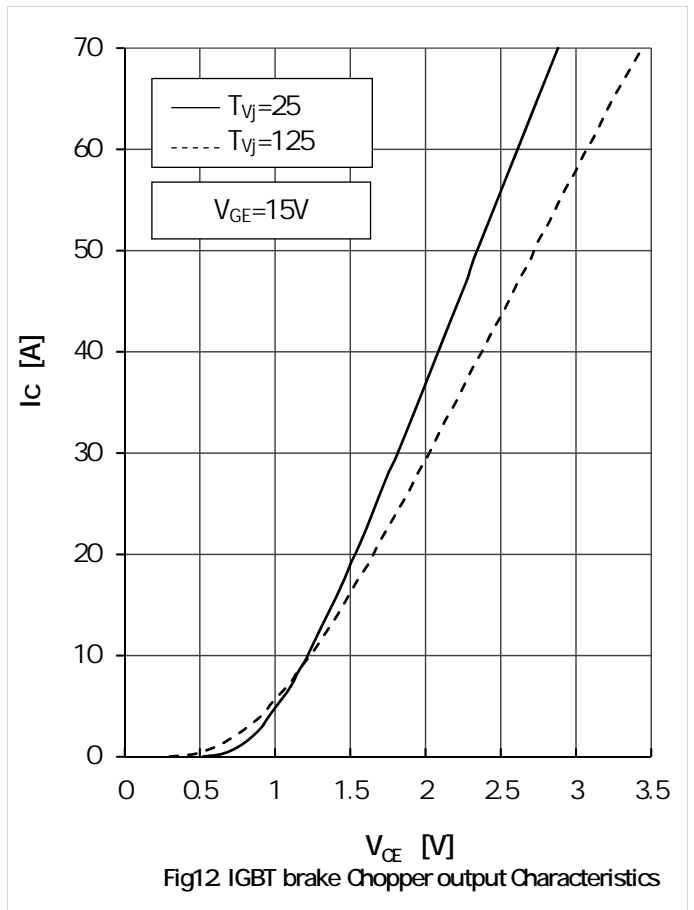
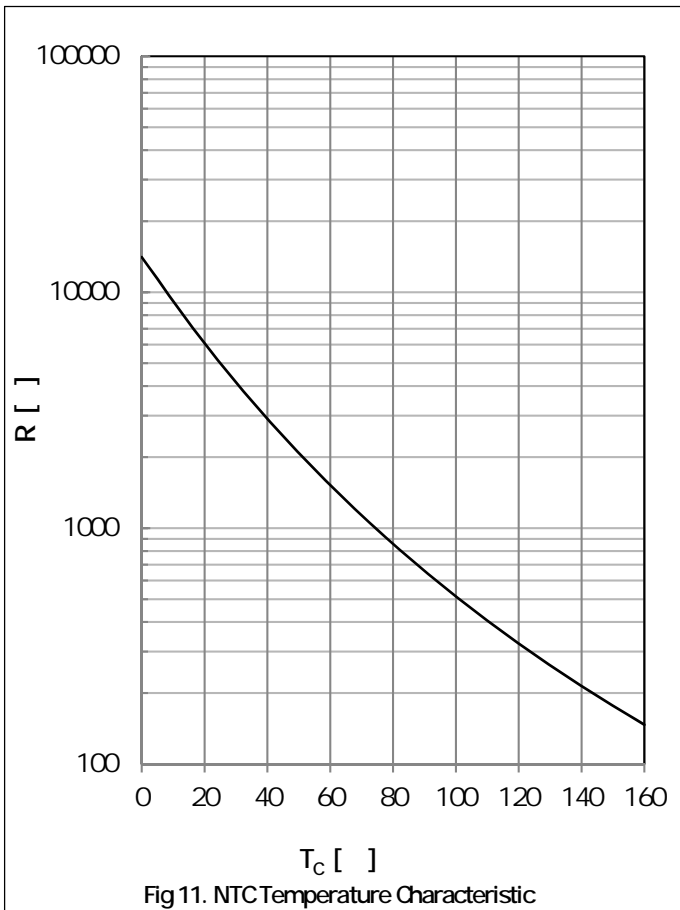
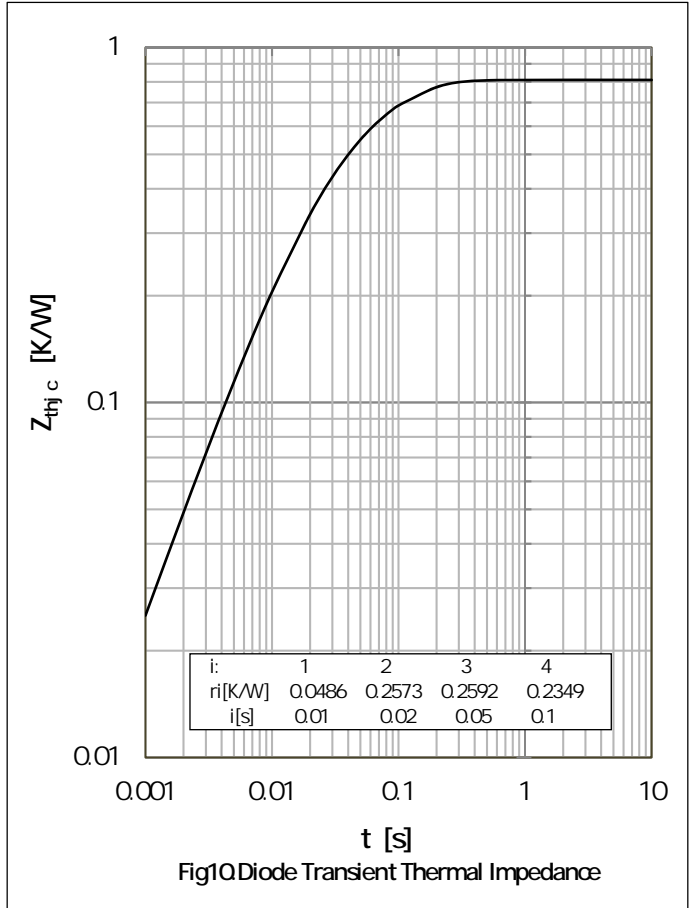
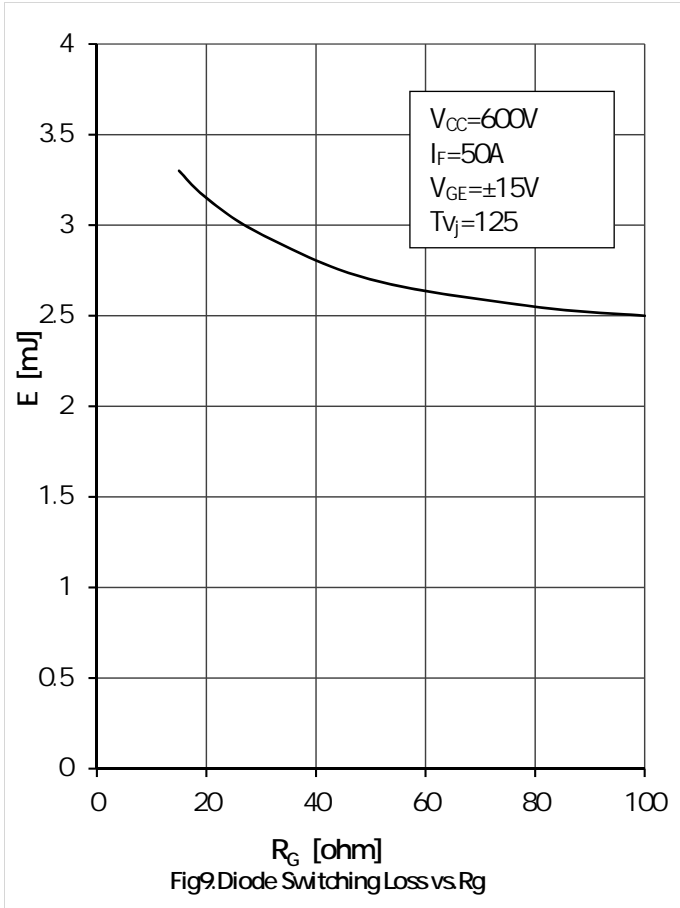





## ● Circuit Diagram

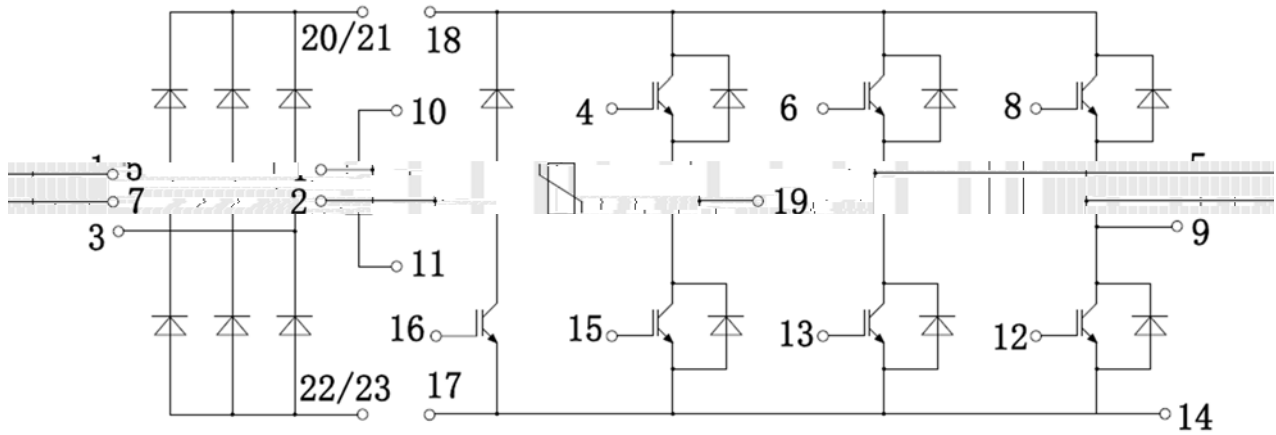

## ● Package Outline Information

